

Infrastructure Products



ENIDINE

Global Presence

Enidine is a diversified leading manufacturer of highly engineered critical components and customized technology solutions for growing industrial end-markets in energy infrastructure, electronics, aerospace and transportation. Building on its heritage of innovation, we partner with our customers to deliver enduring solutions to the key industries that underpin our modern way of life.

Enidine provides custom seismic isolation and protection products for unique infrastructure applications worldwide.

Enidine's engineering staff and technical sales personnel are available to assist you with all of your application needs.

- With a proven track record of operating with lean manufacturing, Enidine produces higher quality custom products with greater efficiency and within shorter lead times.
- Enidine manufacture's all of our products in-house, giving you fast reliable service to meet your critical application needs with on-time delivery.
- Here at Enidine we have a proven track record in the infrastructure market with cutting edge technologies and engineering support, we can provide a custom solution to meet any need globally..

Our website features a worldwide representative lookup to help facilitate fast, localized service at www.enidine.com. For application assistance call our help line at 1.800.852.8508.



Custom Solutions



Power & Utility Sub-Stations

- 6 degree of freedom Isolator Ring
- Stainless Steel construction
- Retrofits to most transformer bushings with little or no modification
- Dynamic tested to IEEE 693



HVAC and Chiller Units

- Equipment Seismic Isolation stand
- Combined Isolation Bearing, Elastomeric damping and Wire Rope Isolator technologies
- Protects equipment from vertical and horizontal seismic inputs
- No maintenance
- Chillers, HVAC, Medical Equipment



Power Plants

- WEAR™ Pipe Restraint/Vibration Isolator
- Nuclear, fossil generation plants, refineries and structural
- No oil, seals, greases or maintenance
- Compatible with most pipe attachment hardware



Oil and Gas Offshore Platforms

- Rubber Isolation Bearings
- Tuned mass dampers, generators, chillers and high value assets
- High or low damping configurations
- Can be applied in parallel with viscous damper technology
- 6 to 21 inch diameter

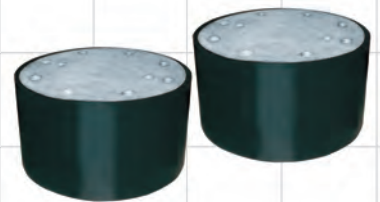

Refineries and Storage Facilities

- HERM (14 Hz Deck)
- Standard Product Selection
- Shipboard Design Expertise
- Electronics Isolation
- Systems Analysis and Integration
- Multi-Axis Isolation
- Minimum Sway Space

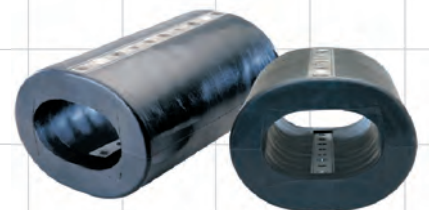

Infrastructure Products

Table of Contents

Linear Dampers

LD-500 Series	
Dimensional Data and Performance Curves.....	1
LD-700 Series	
Dimensional Data and Performance Curves.....	2
LD-1100 Series	
Dimensional Data and Performance Curves.....	3
LD-1500 Series	
Dimensional Data and Performance Curves.....	4

Fluid Viscous Dampers

FVD-B Series	
Dimensional Data	5
Performance Curves	6
FVD-H Series	
Dimensional Data	7
Performance Curves	8

Applications and Capabilities	9-10
--------------------------------------------	------

How to Order	11
---------------------------	----

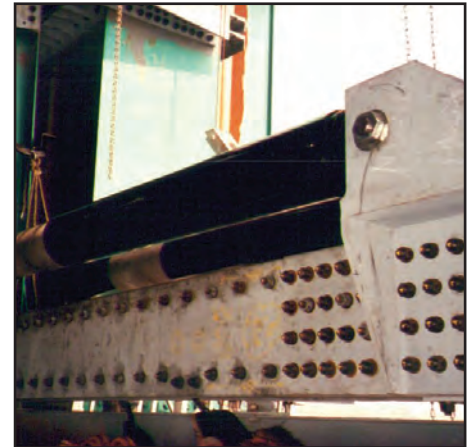

**We Provide Highly
Engineered Customized
Solutions for Every
Unique Customer.**

Linear Damping Devices

LD-500 Series

Technical Data

LD Damper Series are typically recommended for use on TMD (Tuned Mass Damper) Systems or applications requiring high energy dissipation demand and tight space restrictions.

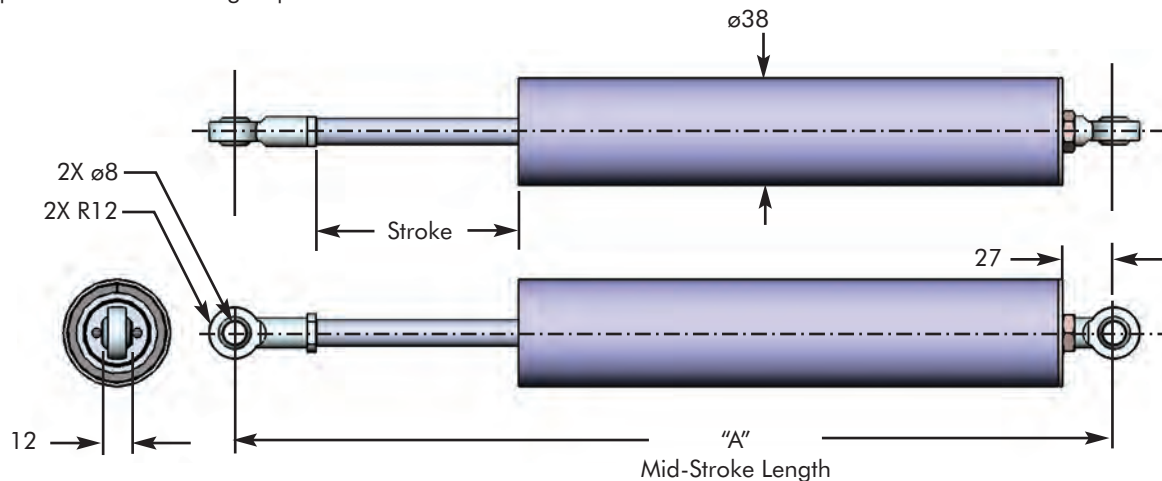

Catalog No./Model	Stroke (mm)	A (mm)	FMax. (kN)	Power Dissipation Capacity			Unit Weight (Kg)
				3 Minutes (Watts)	10 Minutes (Watts)	Continuous (Watts)	
LD510	100	290	4.0	238	88	47	0.7
LD515	150	365	4.0	280	104	58	0.8
LD520	200	440	3.0*	322	121	69	0.9
LD530	300	590	2.0*	402	154	91	1.2
LD540	400	740	1.4*	482	187	112	1.4

*Maximum Force Reduced Due to Buckling Failure Mode. *Cylinder buckling load for cap pivot mounts determined in accordance with NFPA/T3.6.37 R1-2010, Hydraulic fluid power - Cylinders - Method for determining the buckling load." Buckling load analyzed at mid-stroke damper position.

Damping Configurations

When ordering please specify the constitutive law damping coefficient C (kN-sec/m), where $F = C \times V$

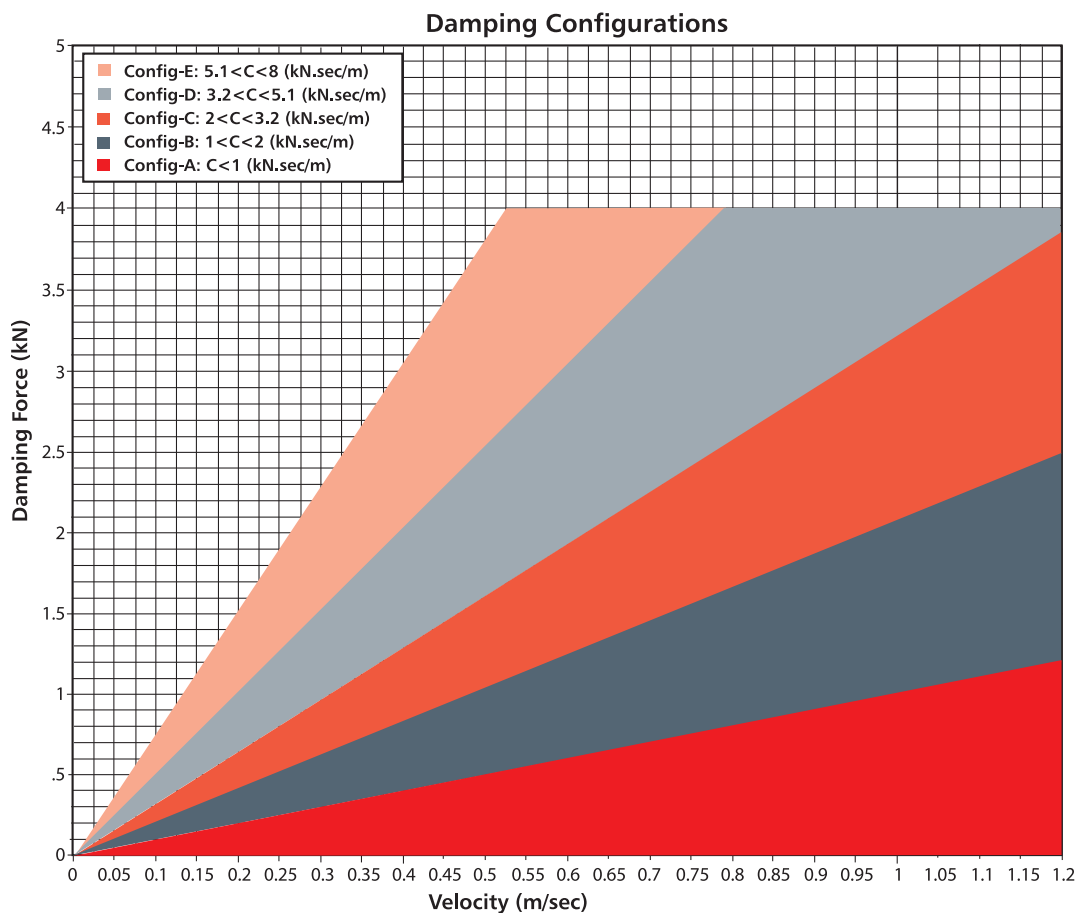

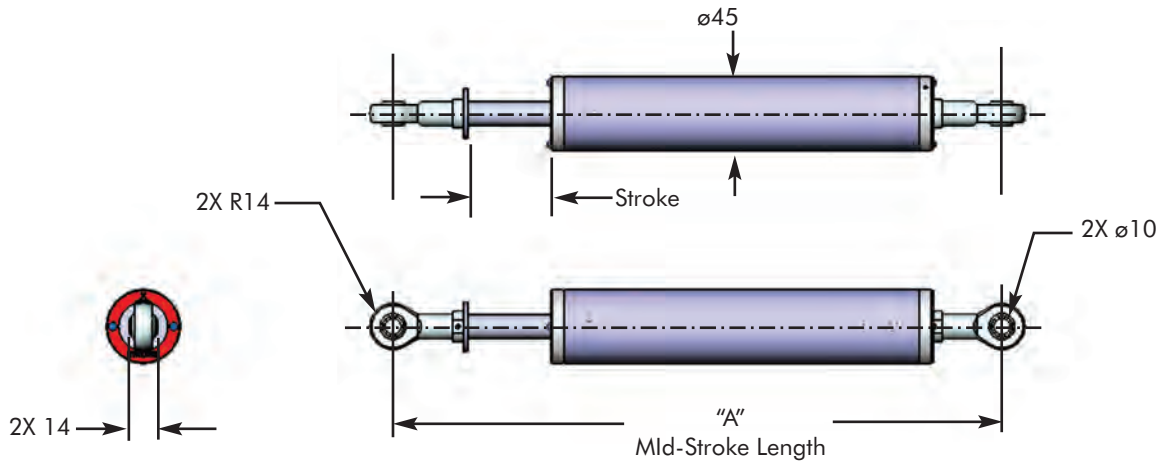

Catalog No./Model	Stroke (mm)	A (mm)	FMax. (kN)	Power Dissipation Capacity			Device Stiffness Ref. (kN/mm)	Unit Weight (Kg)
				3 Minutes (Watts)	10 Minutes (Watts)	Continuous (Watts)		
LD710	100	371	10	400	140	50	6.2	2.1
LD715	150	447	10	470	170	65	4.2	2.4
LD720	200	522	10	540	190	75	3.2	2.7
LD730	300	674	10	680	240	100	2.1	3.3
LD740	400	825	10	820	300	125	1.6	3.9
LD750	500	977	7.5*	960	350	150	1.3	4.4
LD760	600	1129	5.5*	1120	400	175	1.1	5.0

*Maximum Force Reduced Due to Buckling Failure Mode. *Cylinder buckling load for cap pivot mounts determined in accordance with NFPA/T3.6.37 R1-2010, Hydraulic fluid power - Cylinders - Method for determining the buckling load. Buckling load analyzed at mid-stroke damper position.

Damping Configurations

When ordering please specify the constitutive law damping coefficient C (kN-sec/m), where $F = C \times V$

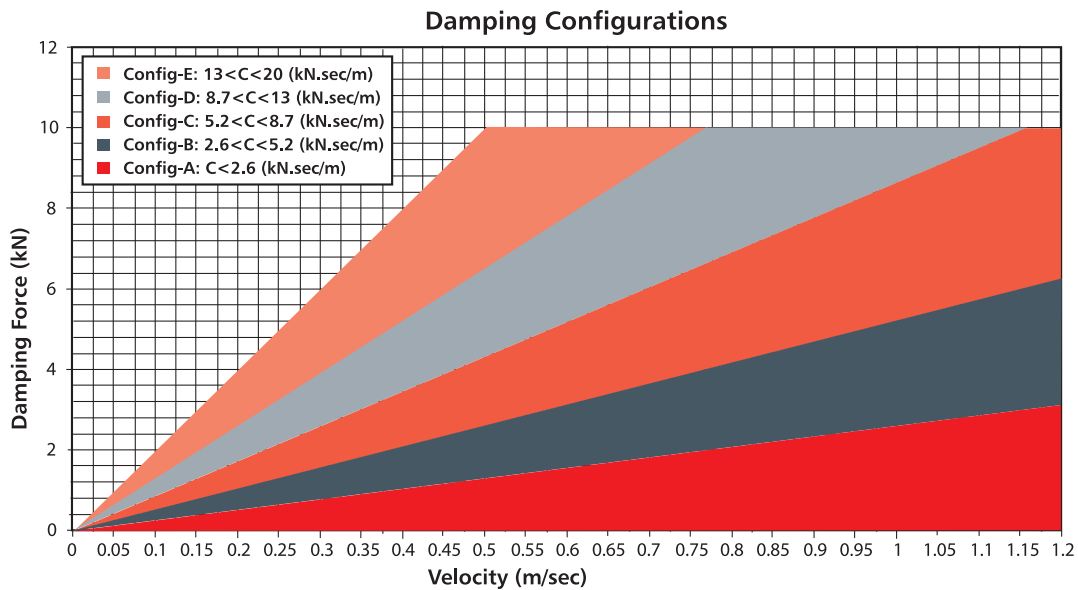

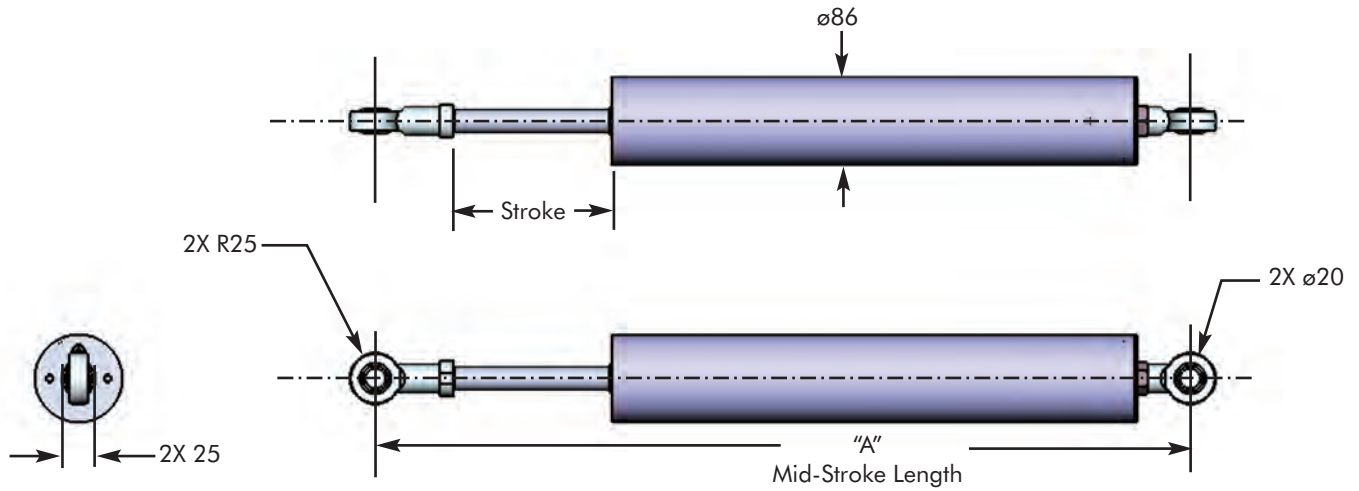

Catalog No./Model	Stroke (mm)	A (mm)	FMax. (kN)	Power Dissipation Capacity			Device Stiffness Ref. (kN/mm)	Unit Weight (Kg)
				3 Minutes (Watts)	10 Minutes (Watts)	Continuous (Watts)		
LD1110	100	500	40	2200	720	164	26.6	11
LD1115	150	575	40	2440	794	186	18.5	12
LD1120	200	650	40	2660	872	210	14.1	13
LD1130	300	800	40	3120	1026	258	9.6	15
LD1140	400	950	30*	3580	1180	305	7.3	17
LD1150	500	1100	25*	4040	1340	352	5.9	19
LD1160	600	1250	20*	4500	1500	400	4.9	22

*Maximum Force Reduced Due to Buckling Failure Mode. *Cylinder buckling load for cap pivot mounts determined in accordance with NFPA/T3.6.37 R1-2010, Hydraulic fluid power - Cylinders - Method for determining the buckling load.* Buckling load analyzed at mid-stroke damper position.

Damping Configurations

When ordering please specify the constitutive law damping coefficient C (kN-sec/m), where $F = C \times V$

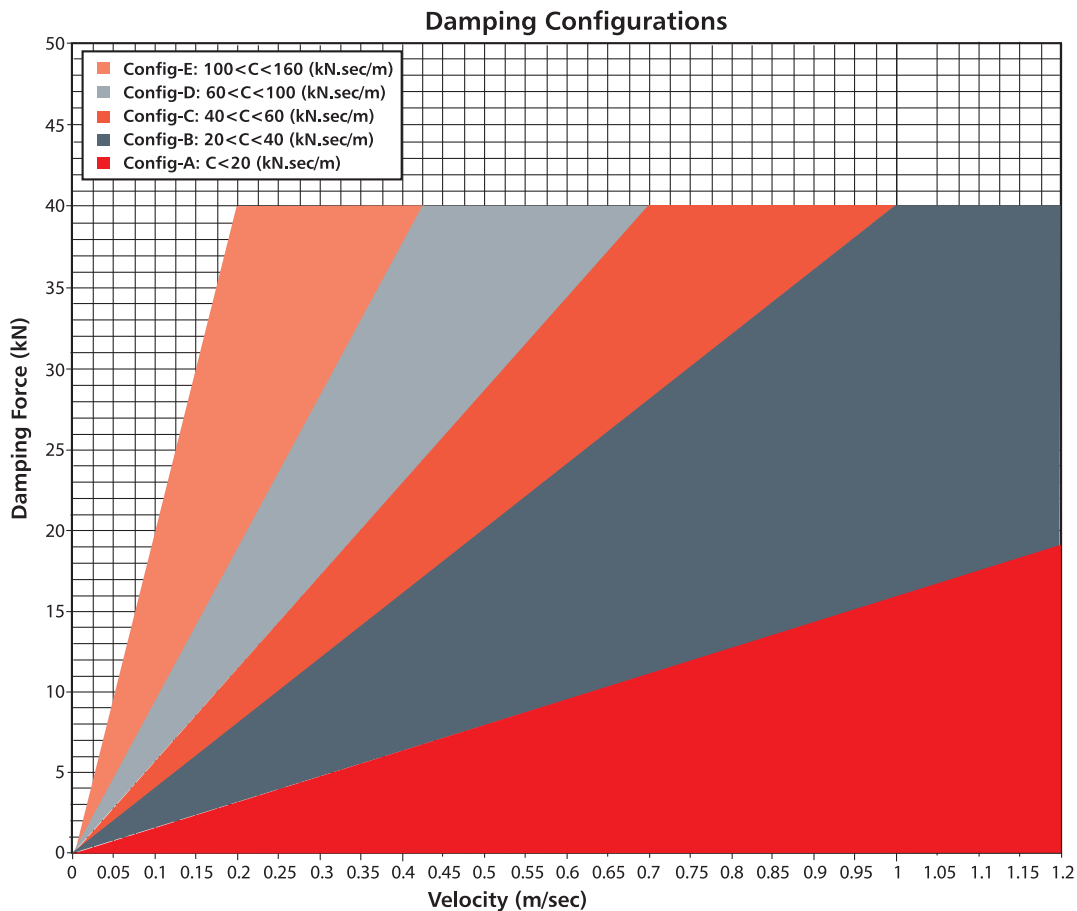

Linear Damping Devices

LD-1500 Series

Technical Data

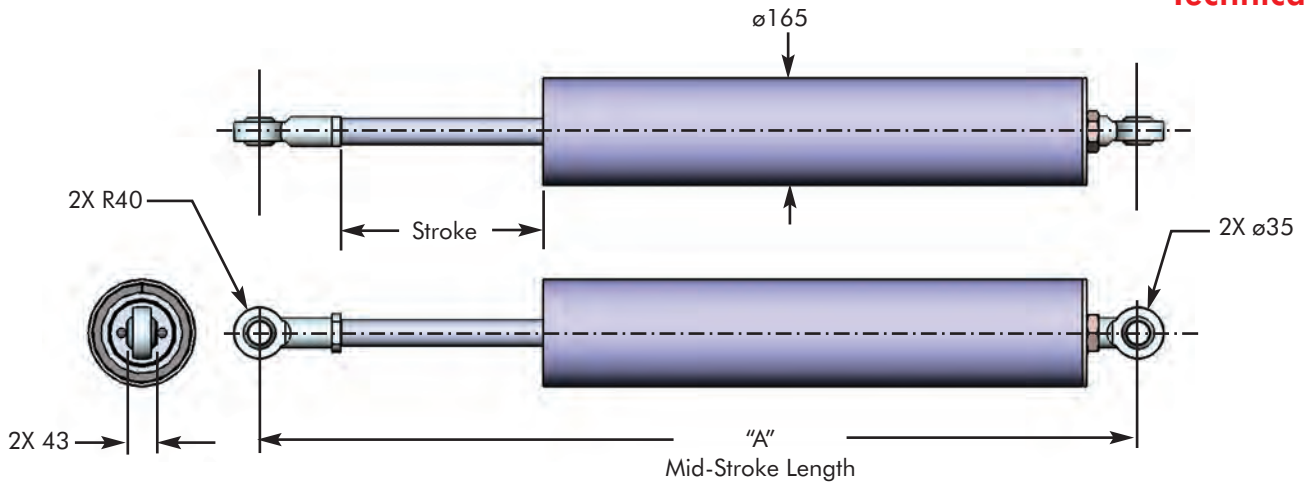

Catalog No./Model	Stroke (mm)	A (mm)	FMax. (kN)	Power Dissipation Capacity			Device Stiffness Ref. (kN/mm)	Unit Weight (Kg)
				3 Minutes (Watts)	10 Minutes (Watts)	Continuous (Watts)		
LD1510	100	600	200	8700	2720	330	99	50
LD1515	150	675	200	9700	3020	380	71	53
LD1520	200	750	200	10650	3320	425	55	57
LD1530	300	900	200	12500	3910	520	38	64
LD1540	400	1050	200	14400	4500	615	29	71
LD1550	500	1200	200	16300	5100	710	24	79
LD1560	600	1350	200	18200	5700	810	20	86

Damping Configurations

When ordering please specify the constitutive law damping coefficient C (kN-sec/m), where $F = C \times V$

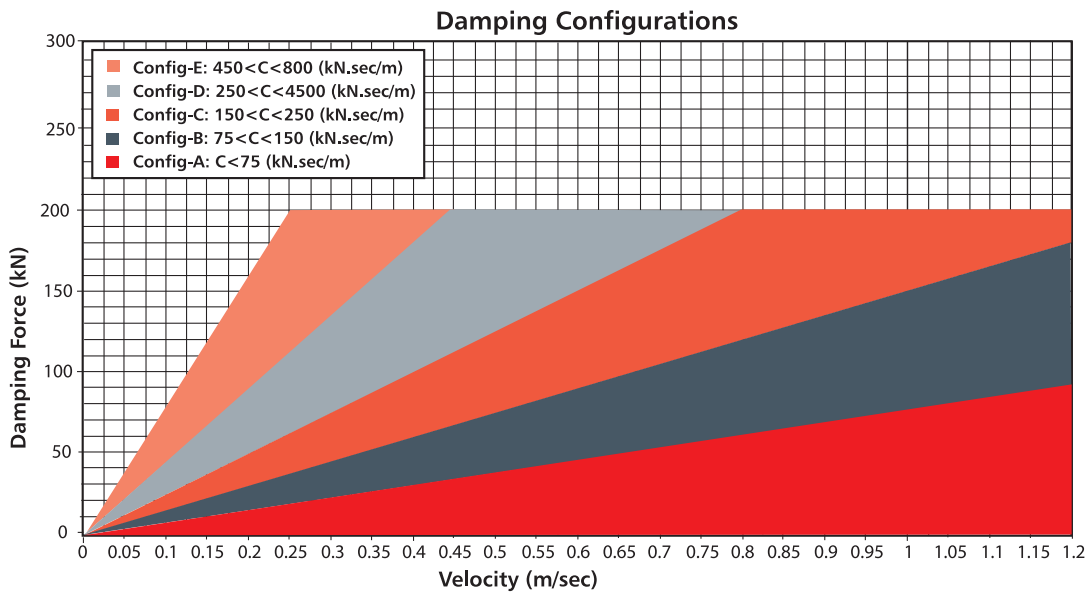

The FVD-B Series dampers are typically utilized on bridge and base isolation platforms requiring a long cycle life. This custom orifice designed damper provides the desired force versus velocity relationship symmetrically in both tension and compression directions, thermal compensation, and easy preventative maintenance inspection.

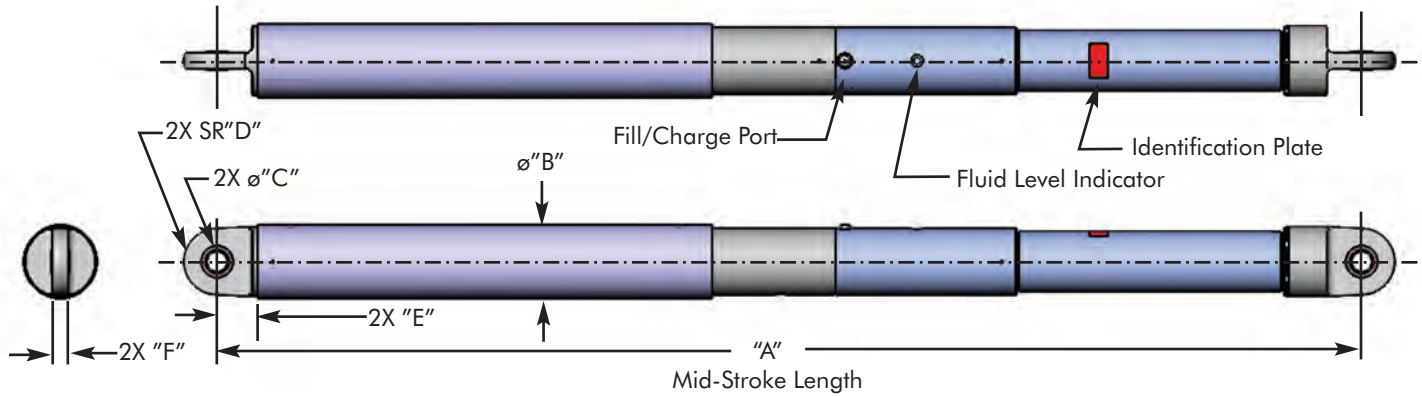

Catalog No./Model	Max. Damping Force FMCE (kN)	Stroke ± S (mm)	Pin-Pin at Mid-Stroke "A" (mm)	Max. O.D. "B" (mm)	Mounting Pin Diameter "C" (mm)	Clevis Radius "D" (mm)	Clevis Depth "E" (mm)	Clevis/Bearing Width "F" (mm)	Unit Weight (Kg)
FVD-B-300-1200	300	600	3790	166	40	74	70	35	262
FVD-B-450-1200	450	600	3851	185	50	90	83	46	344
FVD-B-600-1200	600	600	3874	210	50	96	83	46	437
FVD-B-800-1200	800	600	3950	242	70	120	108	55	593
FVD-B-1000-1200	1000	600	4011	267	80	130	121	60	735
FVD-B-1200-1200	1200	600	4062	286	80	134	121	60	855
FVD-B-1500-1200	1500	600	4124	318	90	150	134	65	1085
FVD-B-2000-1200	2000	600	4244	356	110	180	166	80	1445

Note: 1. Various stroke lengths available. Pin-Pin length at mid-stroke position can be determined by adding 2.5x the stroke length change.

2. Velocity exponent α is available from 0.2 - 1.0

3. Weight and dimensions are for reference only. Consult ITT Enidine Inc. for detailed information before placing order.

4. Additional designs and modifications are available based on project specifications.

Damping Characteristics

$$F = CV^\alpha$$

F: Damping Force, kN

V: Relative Velocity, m/sec

C: Damping Coefficient, kN/(m/sec) $^\alpha$

α : Velocity Exponent

Shown below are graphs depicting the damping force versus the velocity for various damping coefficients and velocity exponents. Refer to page 11 for how to specify the damping characteristics when ordering.

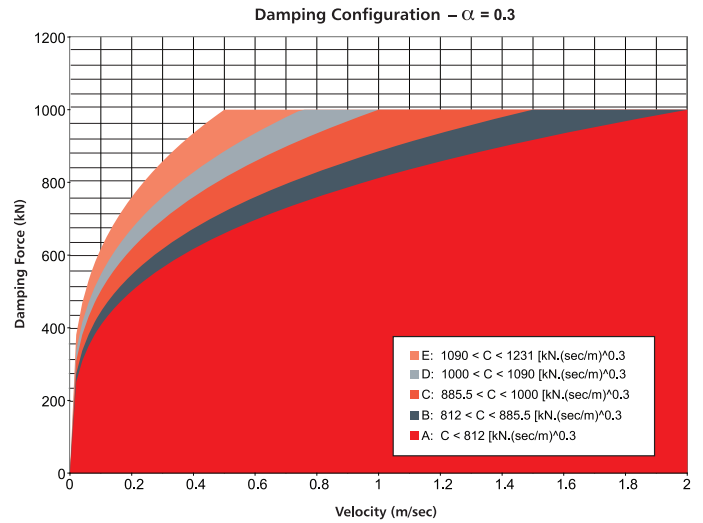
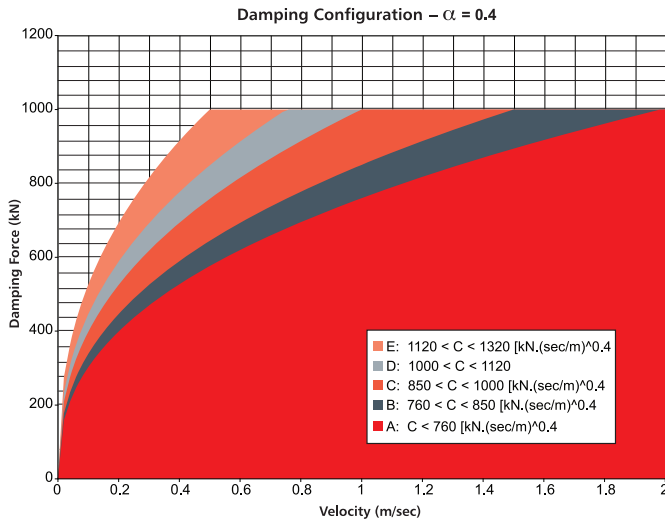
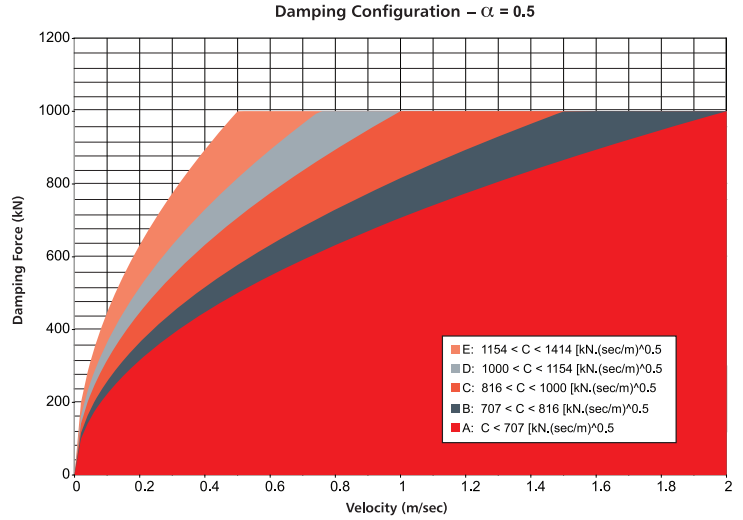
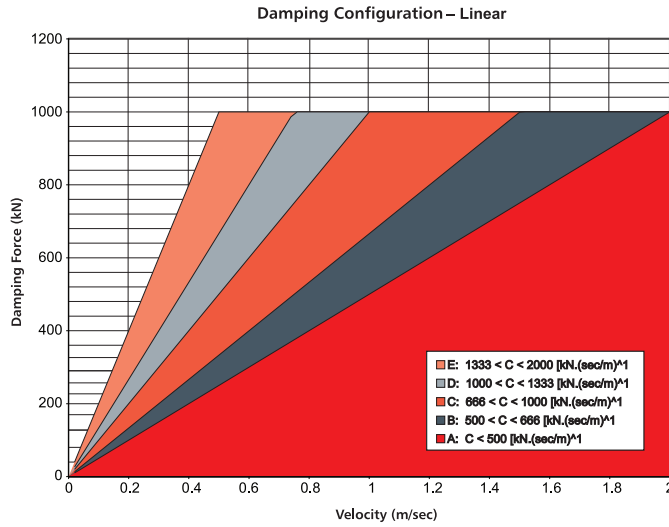

The FVD-H Series dampers are typically utilized on building applications, mounted indoors, where the damper is not under constant vibration or movement.

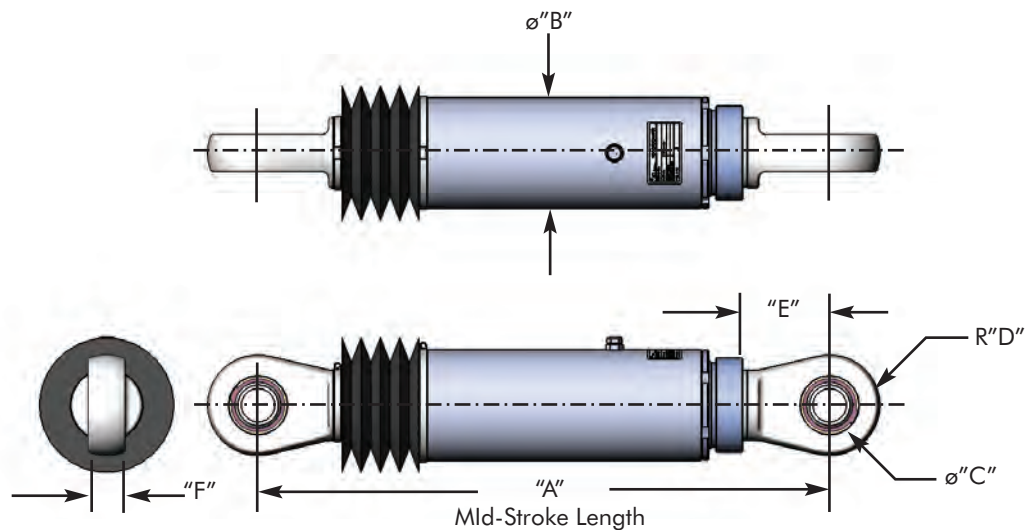

Catalog No./Model	Max. Damping Force FMCE (kN)	Stroke ± S (mm)	Pin-Pin at Mid-Stroke "A" (mm)	Max. O.D. "B" (mm)	Mounting Pin Diameter "C" (mm)	Clevis Radius "D" (mm)	Clevis Depth "E" (mm)	Clevis/Bearing Width "F" (mm)	Unit Weight (Kg)
FVD-H-500-150	500	75	969	147	51	70	89	48	80
FVD-H-750-150	750	75	1020	178	64	86	112	58	125
FVD-H-1000-150	1000	75	1070	201	77	104	134	67	173
FVD-H-1500-150	1500	75	1140	248	89	120	156	77	274
FVD-H-2000-150	2000	75	1210	286	102	135	178	86	385

- Note: 1. Various stroke lengths available. Pin-Pin length at mid-stroke position can be determined by adding 2.5x the stroke length change.
 2. Velocity exponent α is available from 0.2 - 1.0
 3. Weight and dimensions are for reference only. Consult ITT Enidine Inc. for detailed information before placing order.
 4. Additional designs and modifications are available based on project specifications.

Damping Characteristics $F=CV^\alpha$

- F: Damping Force, kN
 V: Relative Velocity, m/sec
 C: Damping Coefficient, kN/(m/sec) $^\alpha$
 α : Velocity Exponent

Shown below are graphs depicting the damping force versus the velocity for various damping coefficients and velocity exponents. Refer to page 11 for how to specify the damping characteristics when ordering.

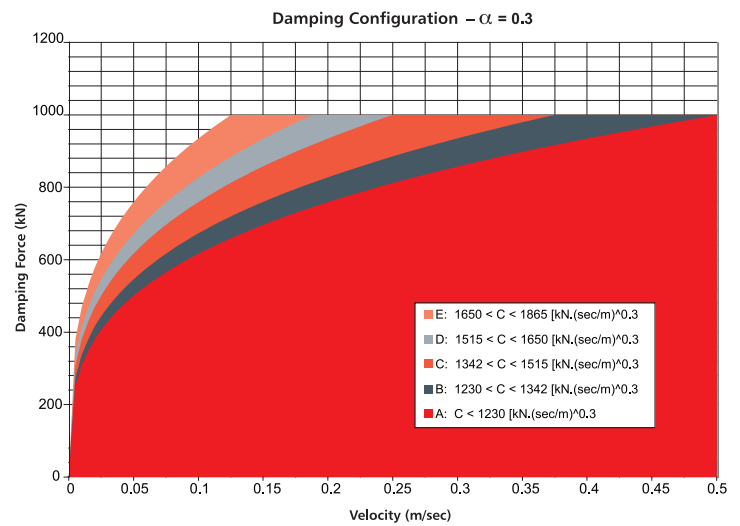
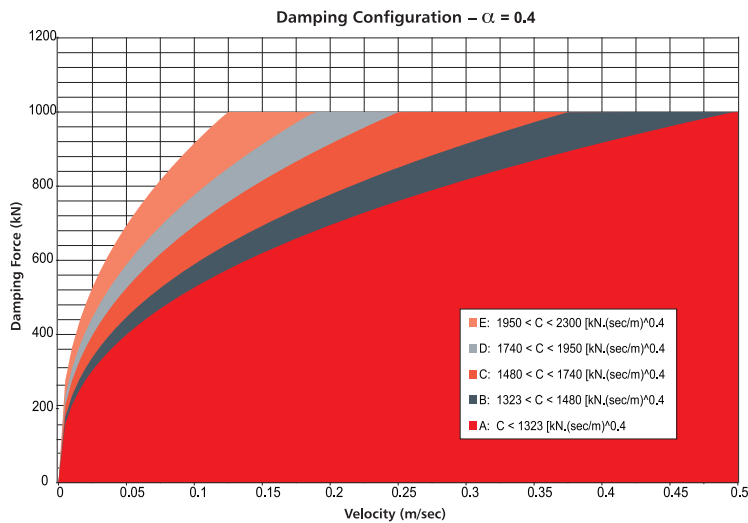
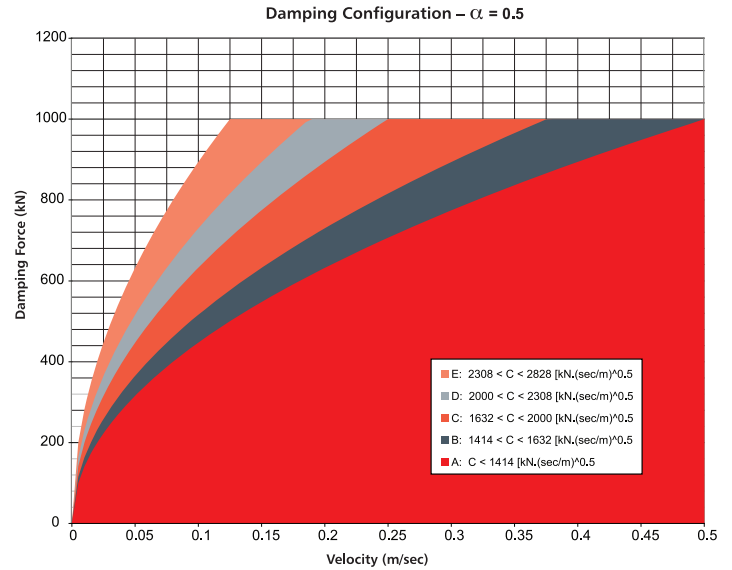
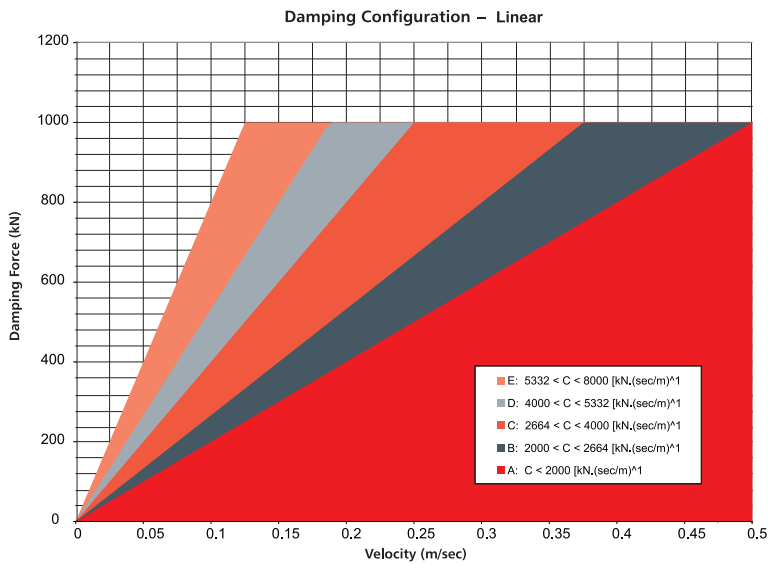

Short Stroke and Long Stroke Fluid Viscous Dampers

Application Overview

Short Stroke Dampers (FVD-H Series)

High-Rise Buildings, Stadiums, City Centers and National Assets

- Viscous Dampers (Short Stroke) Buildings
- Forces up to 2 000 kN
- Diagonal or Chevron Brace mounts
- Velocity Exponent - Alpha 0.2 to linear
- In line, self contained spring loaded reservoir available
- Visual or electronic fluid monitoring system available

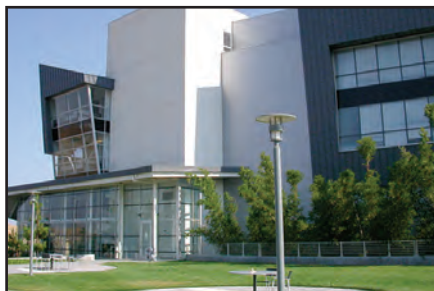

Long Stroke Dampers (FVD-B Series)

Bridges, Highway and Structures

- Viscous Dampers (Long Stroke) Bridges
- Forces up to 2 000 kN
- Strokes up to 2 000 mm
- Velocity Exponent - Alpha 0.2 to linear
- In line, self contained spring loaded reservoir
- Visual or electronic remote fluid monitoring system
- Resusable mechanical fuse option



Research, Design and Engineering

- Static Testing – Including precision electromechanical machines with programmable controllers
- Drop Testing – Up to 1 800 Kg and 15 m/sec.
- Vibration – Electromechanical shakers with digital controllers
- Dynamic Testing – Up to 2 220 kN at 2.0 m/sec.
- 3D CAD Software, Solidworks
- Finite Element Analysis, COSMOS
- Dynamic Software, Visual Nastran



At ITT we will develop products, process and solutions for new applications that will generate excitement among our business partners while setting new industry standards as a premier components supplier.

- Conduct Fundamental Research to Develop Innovations
- Work with Customer to Fully Explore Application/Issues and Engage all Stake Holders
- Provide Solutions, Options and Trade-offs
- Deliver on our Promises

Research and Development

ITT Enidine is active in the fundamental research community and chairs/presents at technical conferences.

Research collaboration with:

- University of California (Irvine)
- University of Buffalo (US)
- Federal University of Santa Catarina (Brazil)
- University of Liverpool (UK)
- The Boeing Corporation (US)
- Bombardier

Design and Development

- All capabilities for design and development in house
- Assemble and test quickly
- Innovation in Technology
- Engineering Experience

Market Focused Solutions

- 3-COM Data Center, Santa Clara, CA.
- Coronado Bridge, San Diego CA.
- Sakhalin Island, Tuned Mass Damper
- Trump Tower, New York, NY
- San Francisco Opera House
- Syncrude Oil Sands Project
- Major Chimney Suppliers in Japan
- Siemens Transformer Isolation

Focused Product Applications

- Power Sub-Stations & Utility Base Isolation
- High-Rise Buildings
- Bridges & Highway Structures
- National Assets, City Centers & Stadiums

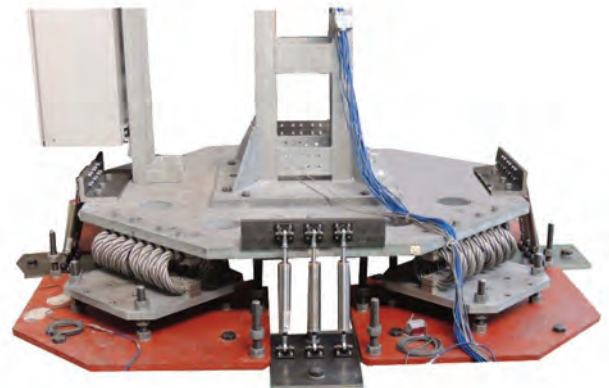

We have the world's broadest set of implementation choices for structural isolation.

LD Series and FVD Series Ordering Information

How to Order

Standard Material and Surface Finish

Rod End:

Ball – Heat Treated Steel

Housing – Heat Treated Steel, Zinc Plated

Piston Rod: Chrome Plated Steel

Bearing: Bronze

Cylinder: Zinc plated steel

Cylinder End: Nickel Plated Steel

Special Materials Upon Request:

Rod End; Ball – Stainless Steel, Housing – Stainless Steel/Teflon Lined (PTFE); Nickel Plated Piston Rod;

Stainless Steel Cylinder; Piston Rod Protection: Bellows/Structural Sleeve

Ordering Example - LD Series

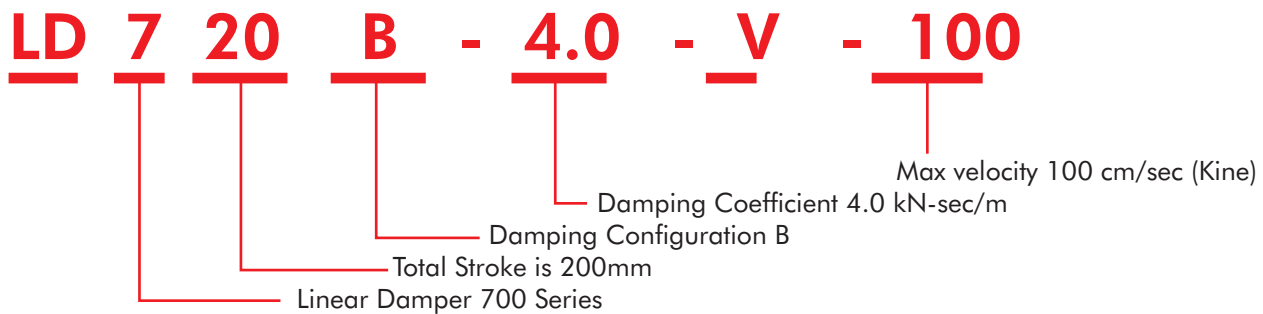

Ordering Example - FVD-B Series



Ordering Example - FVD-H Series



Enidine

7 Centre Drive
Orchard Park, New York 14127 • USA
Phone: 716-662-1900
Fax: 716-667-1909
Email: industrialsales@enidine.com
www.enidine.com

An ITT Company

IND1036R2 4/20